

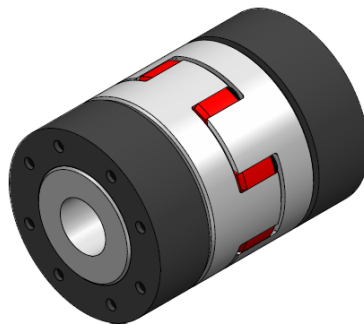

Coupling Series KBE3

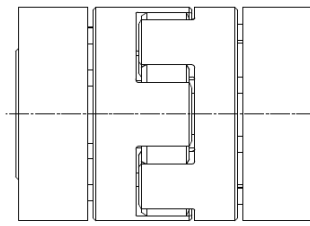
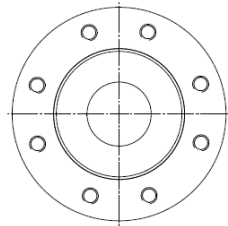

General Information

The installation and operation instructions are an essential factor of the KBK servo insert coupling. It indicates tips for proper assembly, operation and maintenance. Please read these instructions carefully and follow the directions. Non-observance may result in failure of the KBK servo insert coupling.

 The couplings are available in ATEX version. Please note the supplementary operating- and assembly instructions for areas with potentially explosive atmospheres.

Safety Instructions



ATTENTION!

- Installation may be performed by trained and specialized staff only.
- Rotating couplings are hazard areas. The user/operator has to ensure appropriate protective measures. Do not reach into the operation area of the coupling if it is still in operation. Secure the machine against unintentional power-up during assembly work.

Manufacturer's Declaration

In accordance with directive 2006/42/EG annex IIB, shaft couplings are no machines as per the machinery directive, but components for installation in machines. Operation is not permitted unless the directives according to the machinery directives are complied with upon integration in the final product.

Servo insert coupling with clamping ring hub: KBE3



Function

The transmission of the torque is backlash-free and vibration-reducing because of the spider-element. It serves as the compensating element of the servo insert coupling and is determinant for both the characteristics of the coupling and the driveline. For the modification of these characteristics, the spider elements are available in different shore hardness.

Please note:

The backlash-free power transmission is achieved by the prestress of the spider element inside the hubs. This requires an increased axial assembly force when pushing the hubs together. This can be reduced by the use of lubricants based on silicone (e.g. vaseline/white petroleum jelly).

Shaft-hub connections:

KBK servo insert couplings may only be used in accordance with the technical data stated in the catalogue.

Preparation for assembly

Avoid using any force. The shafts and bores of the hubs to be connected must be free from dirt and burrs. Please check the connection dimensions of the shafts (as well as the dimensions regarding the key) and check the tolerances. KBK servo insert couplings have got an H7 fit. This fitting tolerance and the shaft extension facilitate both assembly and disassembly. The recommended fitting tolerance is 0,02mm – 0,05mm.



ATTENTION!

Any oils and fats including molybdenum disulfide or any other high-pressure additives as well as lubricating pastes must not be used.

Assembly

In general, the hubs of the KBK coupling can be installed both separately and in mounted condition. Slide the hubs onto the stub shafts. In the correct axial position, tighten the clamping screws (G) to the torque stated in the table by using a torque wrench. The clearance (F) should be adhered to in order to increase both the compensation of the misalignment and the service life of the spider element.

KBE3 /	14	19	24	28	38	42	48
T _A (Nm) (G)	1,34	2,9	6	6	10	35	35
F (mm)	13	16	18	20	24	26	28

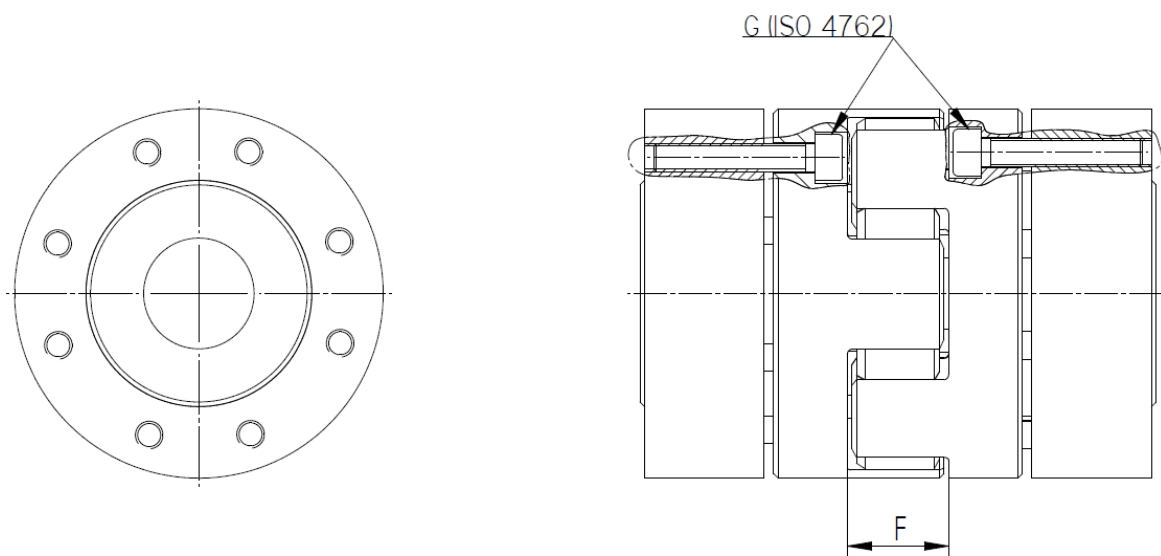

Disassembly

For disassembly of the KBK servo insert coupling loosen the clamping screws (G). Then the hubs can be pushed off the stub shaft. The cone is self-releasing.

Maximum Misalignment

KBK servo insert couplings compensate lateral, axial and angular shaft misalignment.

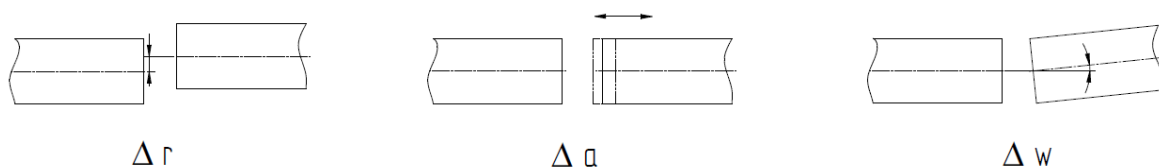

$$\sum \left[\frac{\Delta r}{\Delta r_n} * 100\% + \frac{\Delta a}{\Delta a_n} * 100\% + \frac{\Delta w}{\Delta w_n} * 100\% \right] < 100\%$$

Definition	
Δr	Radial misalignment (installed condition)
Δa	Axial misalignment (installed condition)
Δw	Angular misalignment (installed condition)
Δr_n	Maximum permissible radial misalignment (according to catalogue)
Δa_n	Maximum permissible axial misalignment (according to catalogue)
Δw_n	Maximum permissible angular misalignment (according to catalogue)

 Information!	<p>The maximum guideline value for the different misalignments can be found in our catalogue under 'technical information'. They provide security to compensate operation-related external influences e.g. thermal expansions and / or sinking foundation.</p>
--	--

 ATTENTION!	<p>An exact alignment of the KBK servo insert coupling increases the service life considerably. The load for neighboring bearings is reduced and this will have a positive effect on the running smoothness of the entire driveline.</p>
---	--

Maintenance

During the regular inspection intervals of the servo insert coupling, a visual check and a clearance check of the spider element should be conducted. For backlash-free operation, wear and tear is not permitted.

Otherwise, the following applies:

Size of coupling	max clearance between hub and spider
5 - 14	0,4 mm
19 - 28	0,6 mm
38 - 48	0,9 mm

Transportation

KBK servo insert couplings are delivered ready for installation. Upon incoming goods inspection, the servo insert couplings should be stored in their original packaging and in this way they should be made available for installation. Operating and installation instructions should always be made available where the couplings are used upon assembly.